

TUTORIAL - THE DICETROYERS DICE!

Among the pieces to assemble, you'll find a dice. This is not part of the organizer, but it can be a good starting point to practice!

Tra i materiali da assemblare troverai un dado. Questo componente non fa parte dell'organizer, né del gioco, ma è un ottimo punto di partenza per fare un po' di pratica.

1

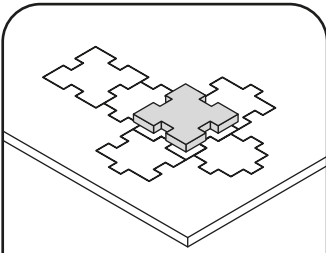

Gently take off

all the pieces.

Stacca delicatamente
dal foglio tutti i pezzi.

2

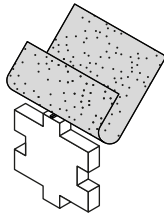

If necessary, use sand paper
to smoothen the borders.

Se necessario rifila con carta
vetrata per legno eventuali
imperfezioni dei pezzi.

3

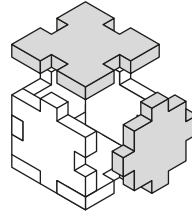

Get familiar with
all the pieces
and check the correct
assembly sequence.

Prendi familiarità con tutti
i pezzi, per assicurarti
che la sequenza di
assemblaggio sia corretta.

4

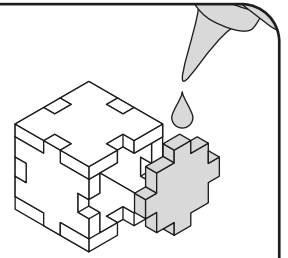

Once verified the correct
assembly sequence, just add
a small quantity of PVA glue
on every joint.

Dopo aver verificato
la sequenza di assemblaggio
aggiungi una piccola quantità
di colla vinilica su tutti
gli incastri per garantirne
la durata nel tempo.

INSTRUCTIONS

A

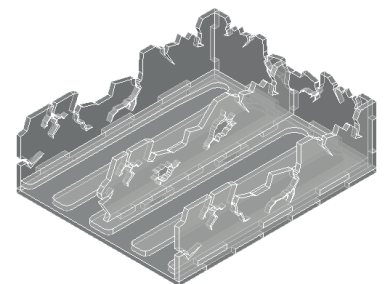
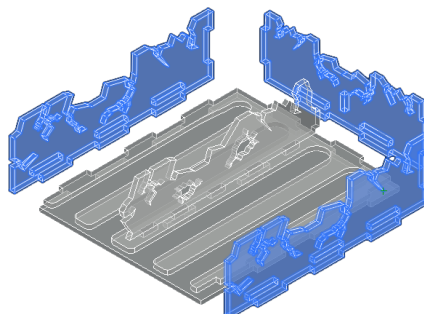
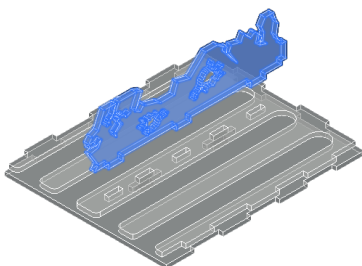
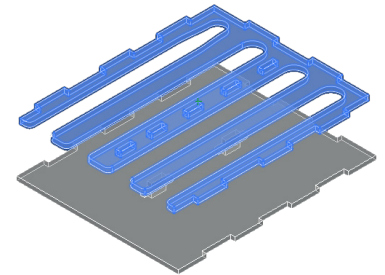
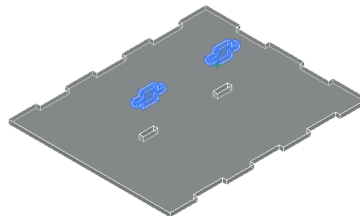
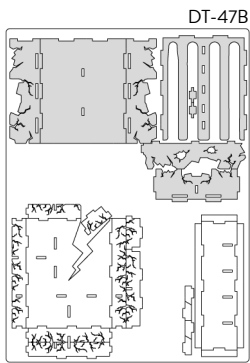

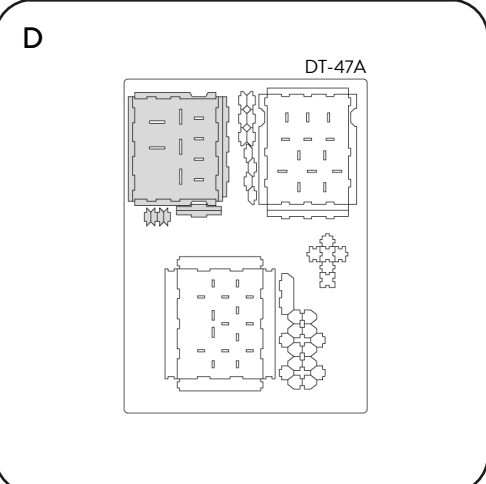
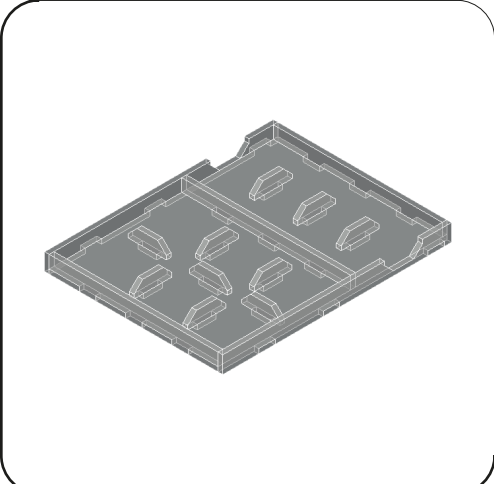
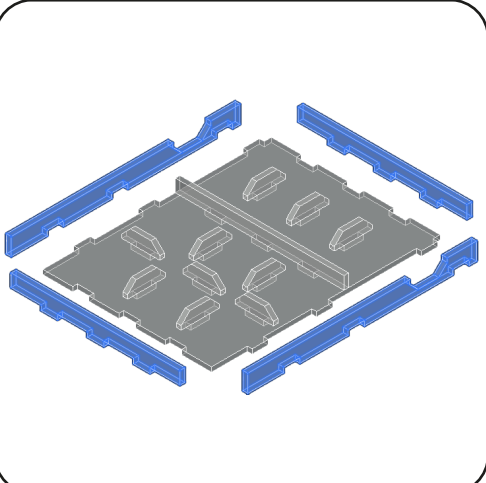
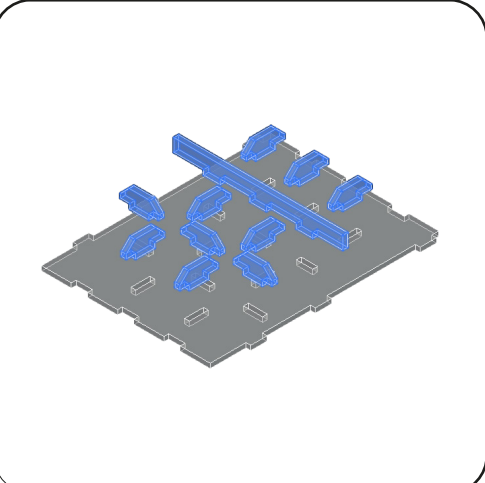
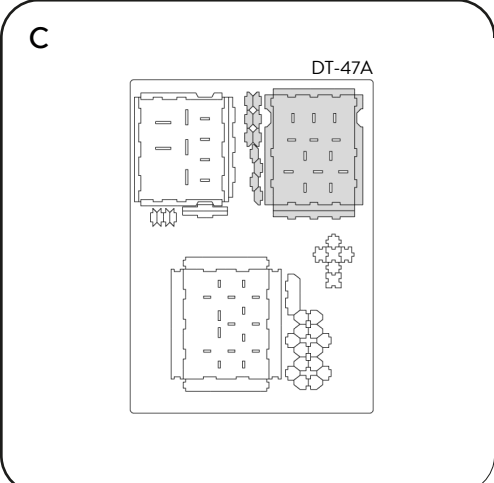
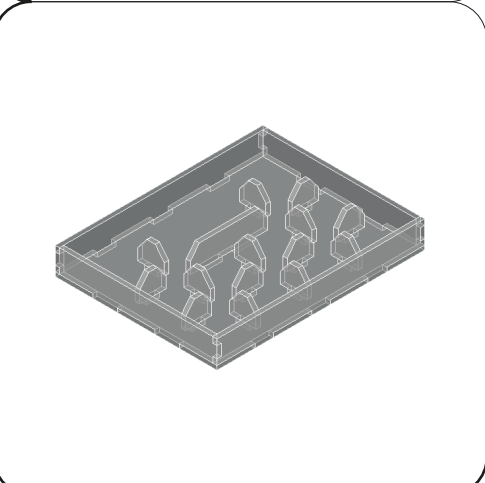
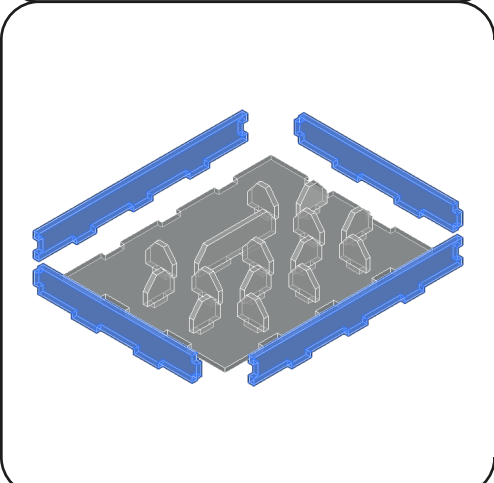
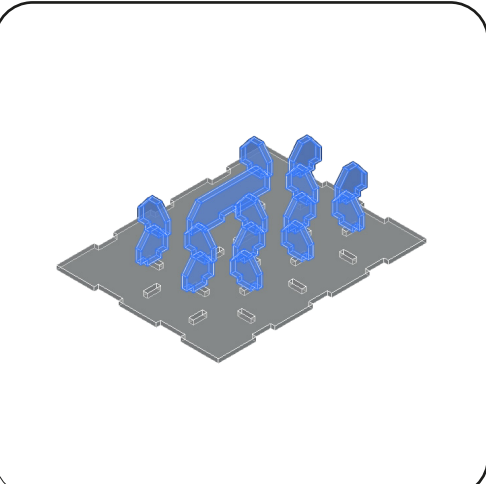
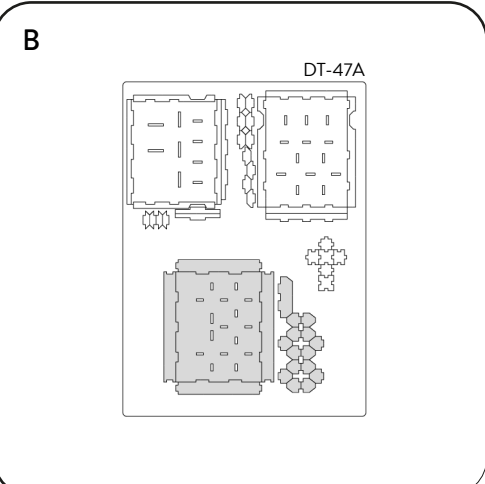
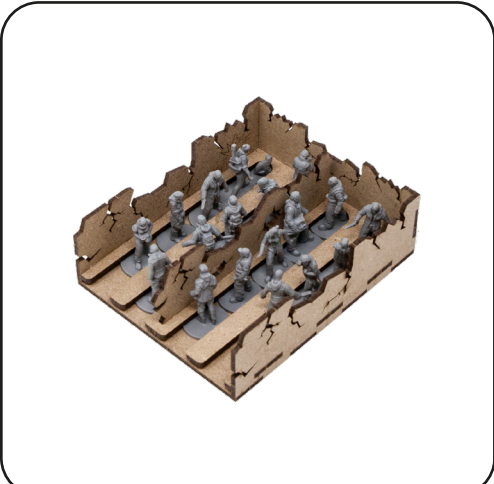

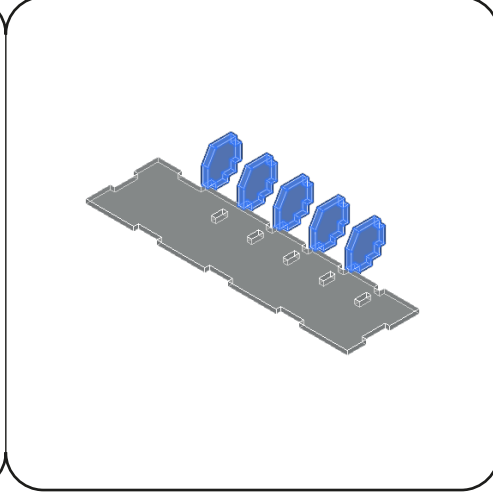
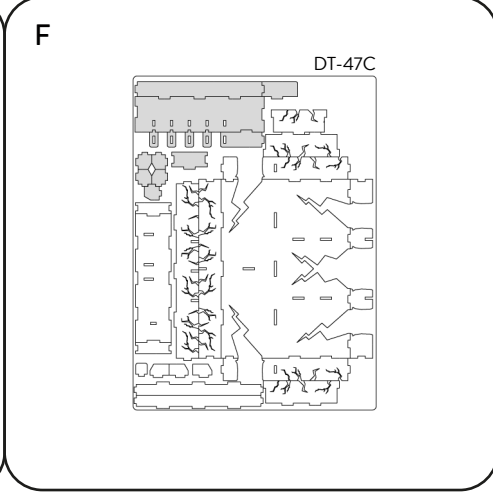
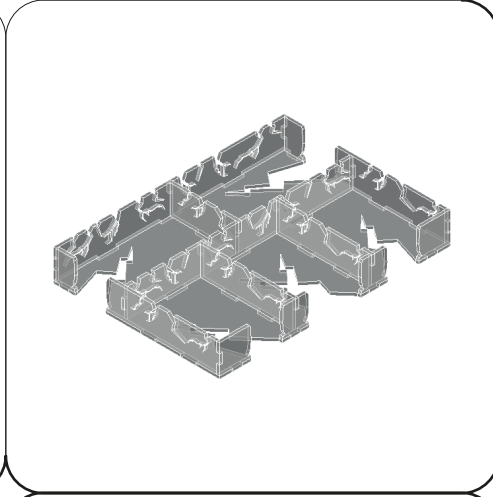
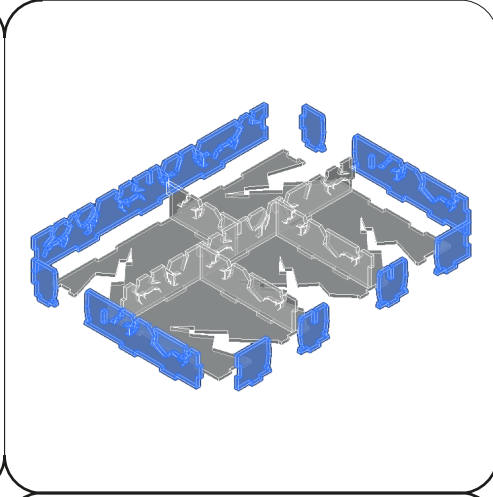
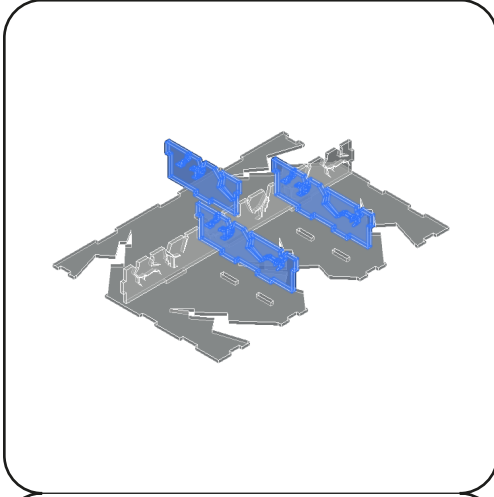
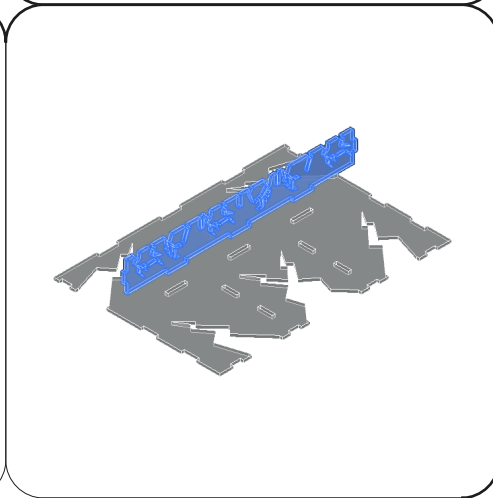
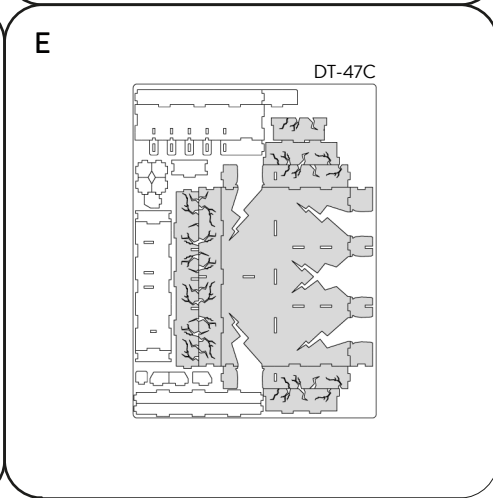
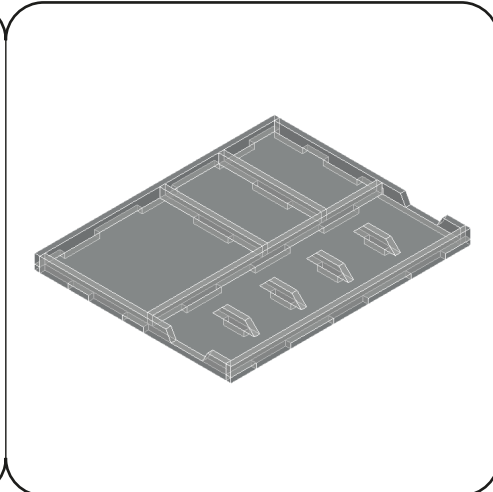
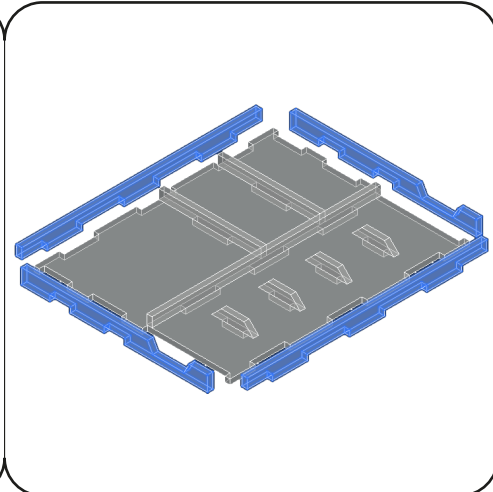
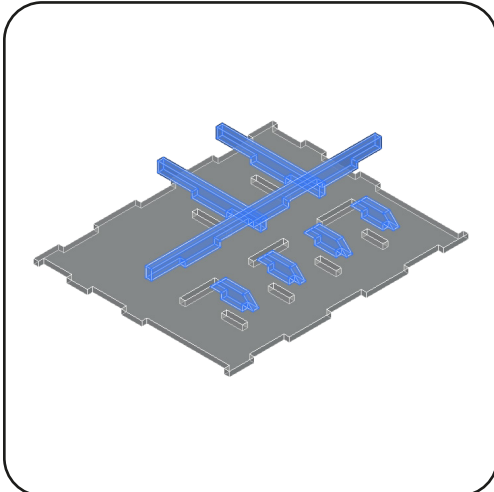

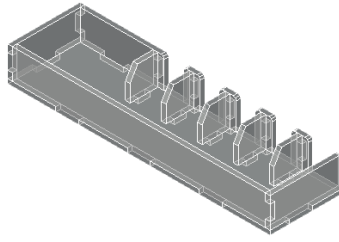
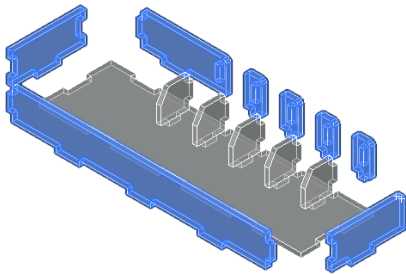

G

DT-47B

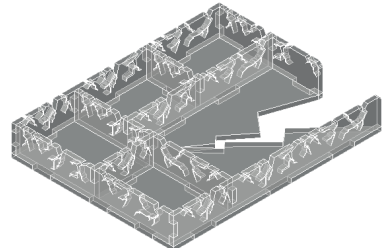
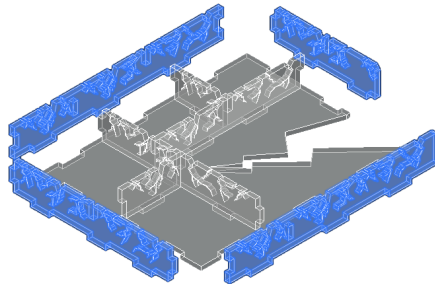
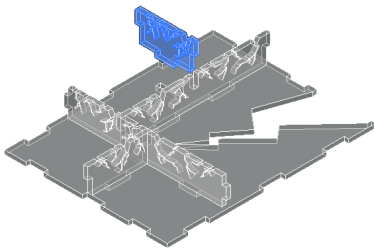
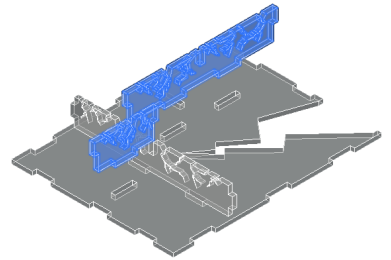
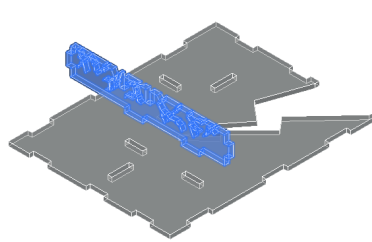
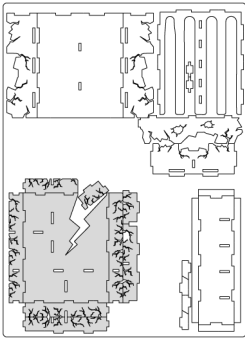

H

DT-47B

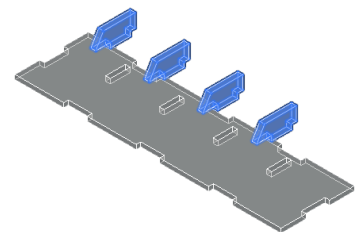
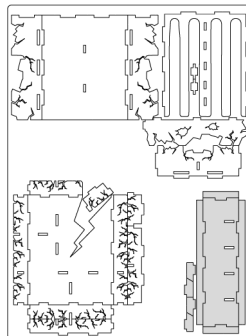

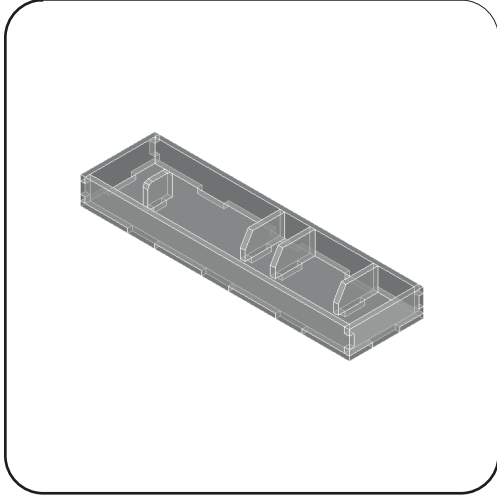
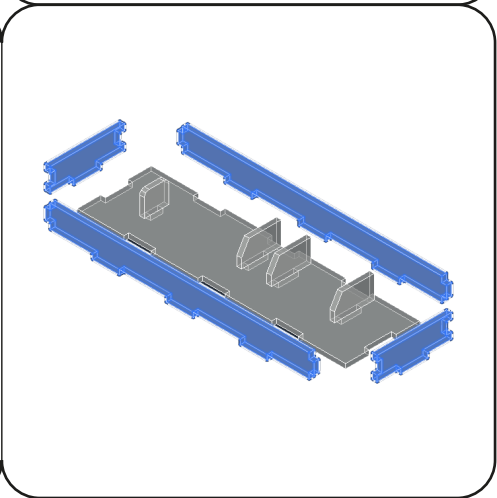
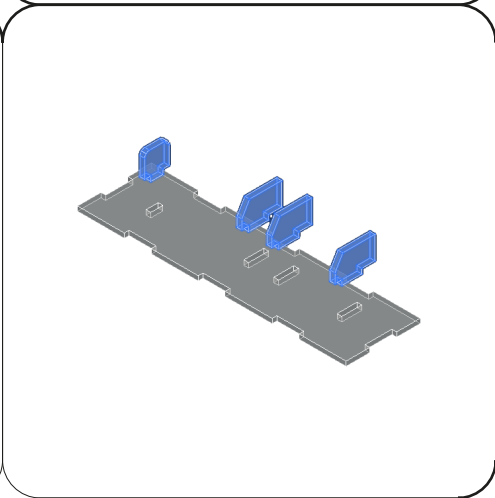
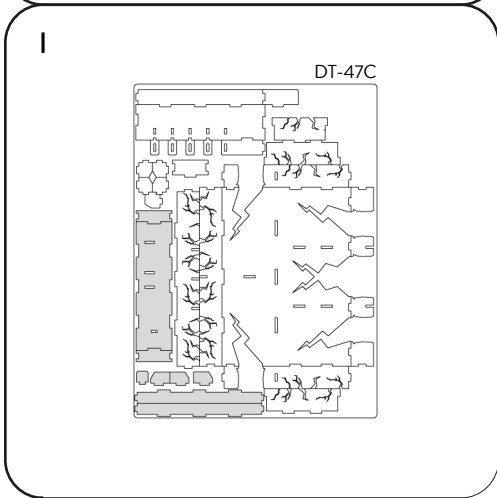
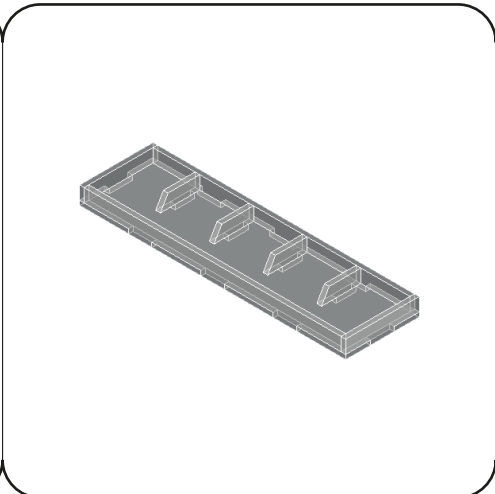
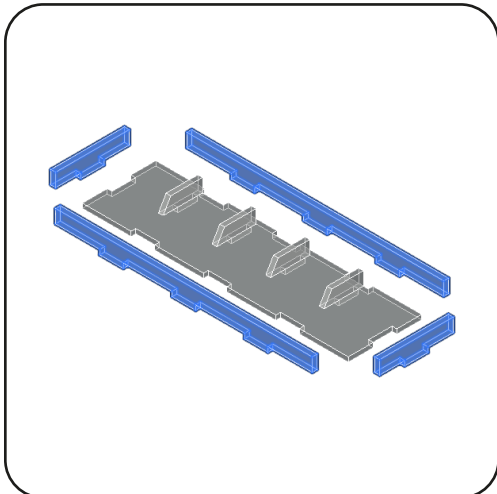

Take care, don't overturn the box!
Riporre con cura la scatola, non ribaltare!



Non-recyclable waste
Smaltire i materiali di scarto nell'indifferenziata

All trademarks and copyrights are the property of their respective owners.
This product is not a toy. Contains small parts that can be swallowed or inhaled. 14+

