

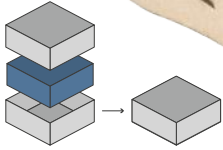

ORGANIZER - COMPATIBLE WITH UNFATHOMABLE



Designed to fit into the game box; flush closure is guaranteed. Progettato per inserirsi all'interno della scatola del gioco; garantisce chiusura a filo*

Designed for both sleeved and unsleeved cards. Adatto sia per carte imbustate che non imbustate*

86

Pieces to assemble
Pezzi da assemblare

28.4 x 28.4 x 7.8 cm

Size of assembled organiser
Dimensioni organizer assemblato

ORGANIZER CAPACITY

2x card holders, with dedicated slots; 1x player standees tray; 1x token holder; 2x miniature holders.
2x portacarte, con slot dedicati; 1x vassoio per standee personaggi; 1x portatoken; 2x portaminature.



* Any doubt? Check out our FAQ page or download the digital version of the instructions on our website!

All trademarks and copyrights are the property of their respective owners.
This product is not a toy. Contains small parts that can be swallowed or inhaled. 14+





ORGANIZER - COMPATIBLE WITH UNFATHOMABLE

TUTORIAL - THE DICETROYERS DICE!

Among the pieces to assemble, you'll find a dice. This is not part of the organizer, but it can be a good starting point to practice!

Tra i materiali da assemblare troverai un dado. Questo componente non fa parte dell'organizer, né del gioco, ma è un ottimo punto di partenza per fare un po' di pratica.

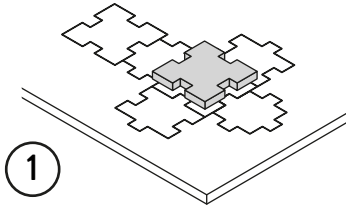

1

Gently take off all the pieces.
Stacca delicatamente dal foglio tutti i pezzi.

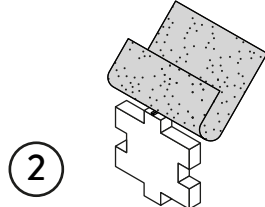

2

If necessary, use sand paper to smoothen the borders.
Se necessario rifila con carta vetrata per legno eventuali imperfezioni dei pezzi.

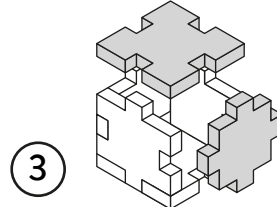

3

Get familiar with all the pieces and check the correct assembly sequence.
Prendi familiarità con tutti i pezzi, per assicurarti che la sequenza di assemblaggio sia corretta.

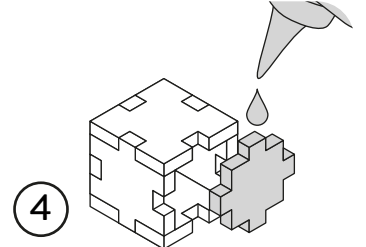

4

Once verified the correct assembly sequence, just add a small quantity of PVA glue on every joint.
Dopo aver verificato la sequenza di assemblaggio aggiungi una piccola quantità di colla vinilica su tutti gli incastri per garantirne la durata nel tempo.

INSTRUCTIONS

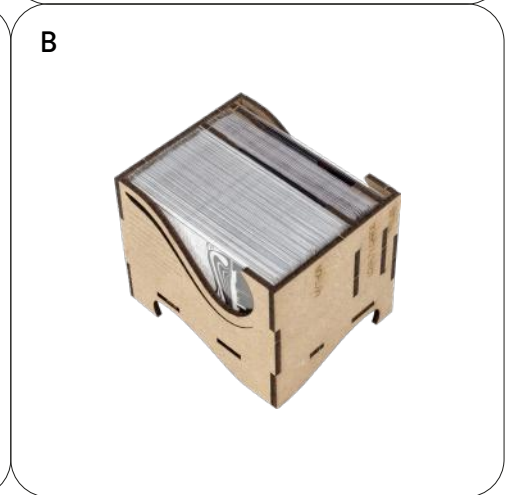
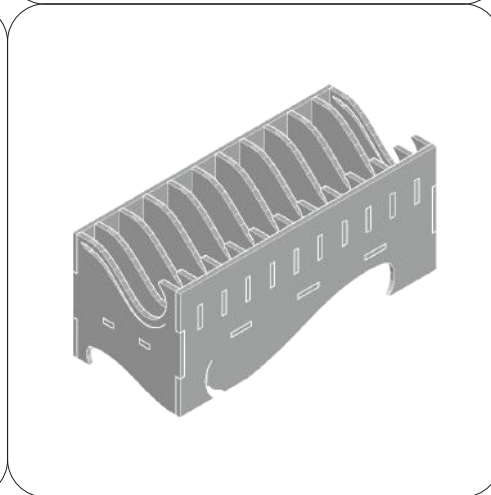
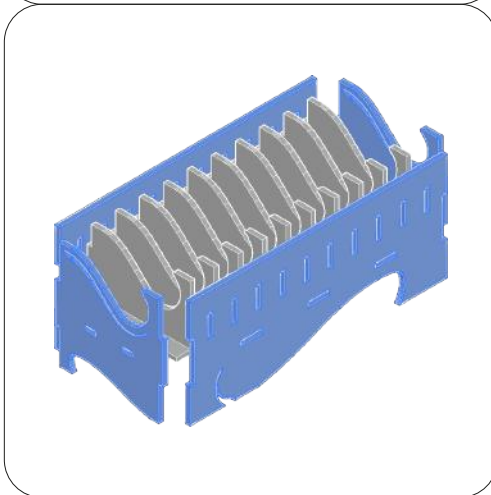
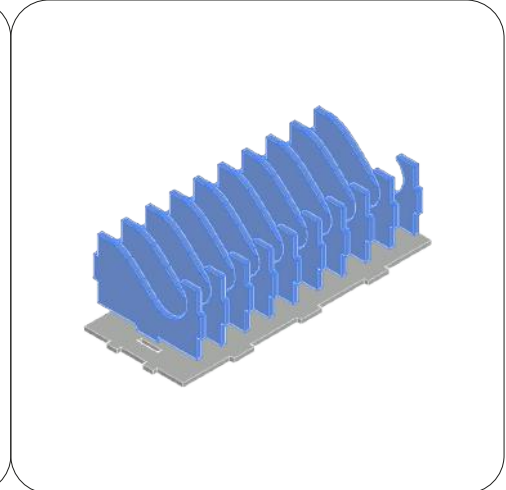
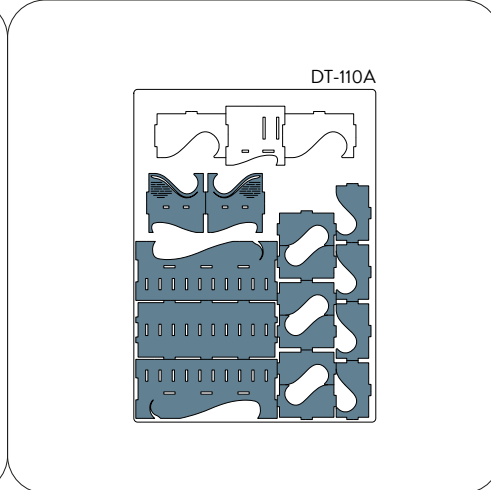

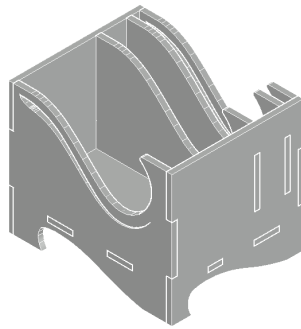
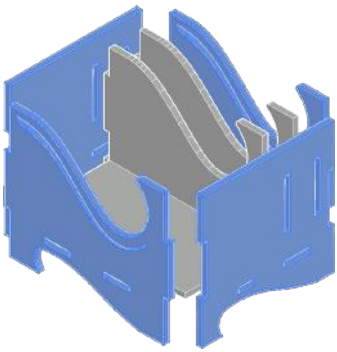
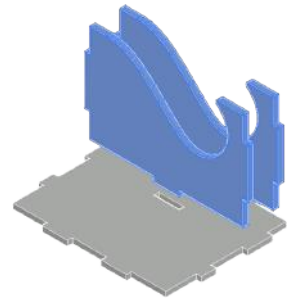
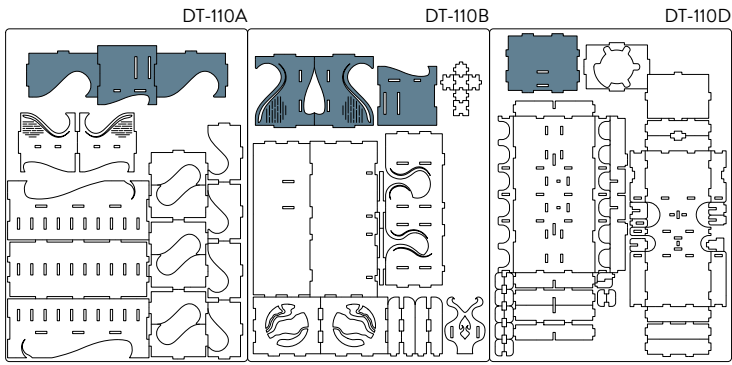

C

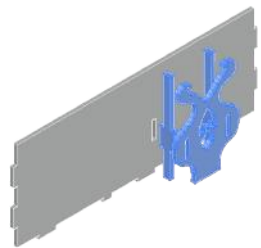
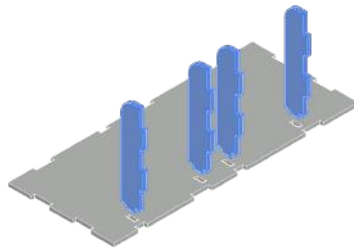
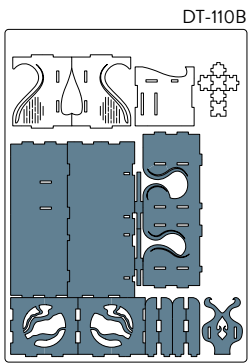

D

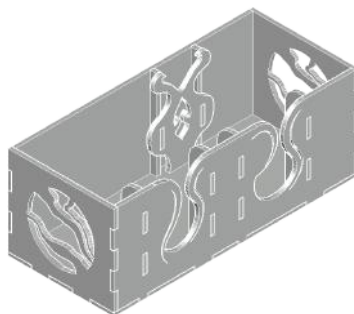
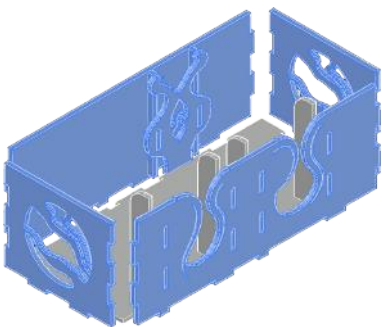

DT-110D

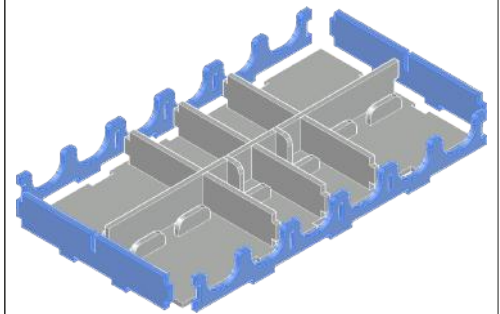
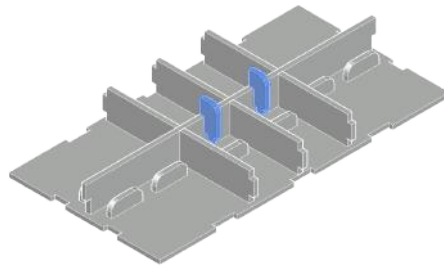
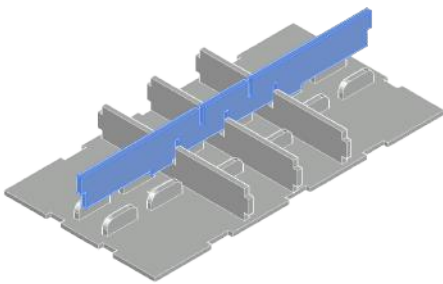
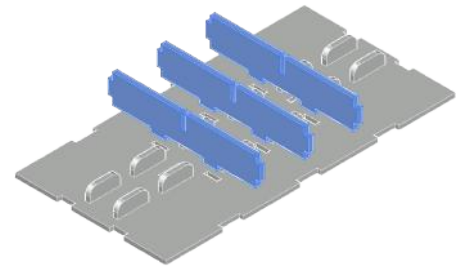
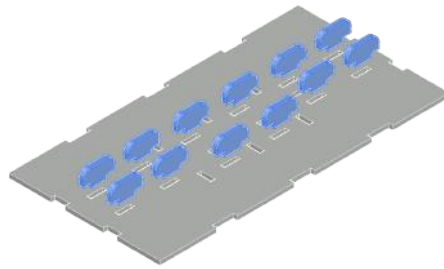
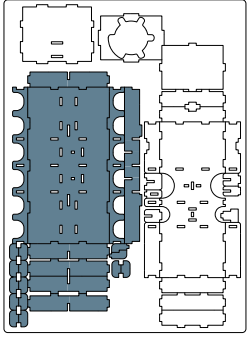

E



DT-110D

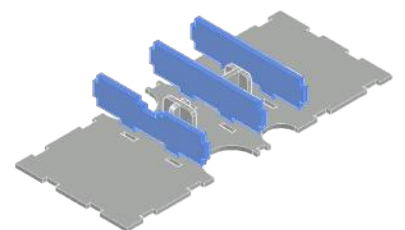
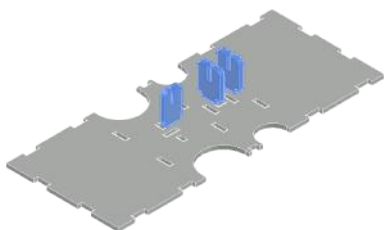
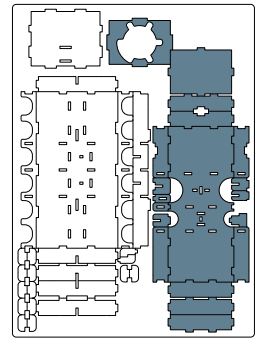

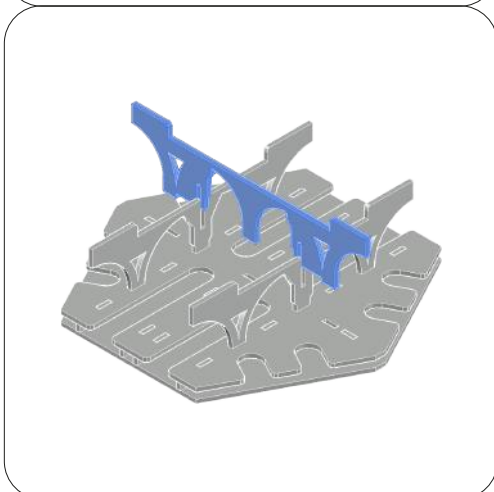
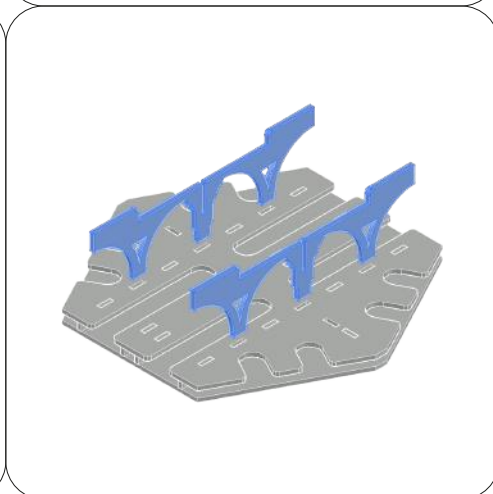
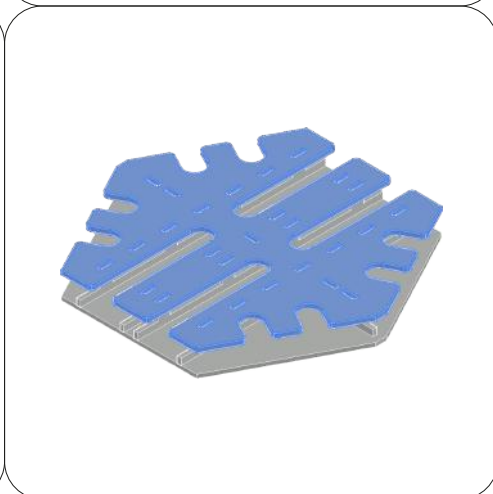
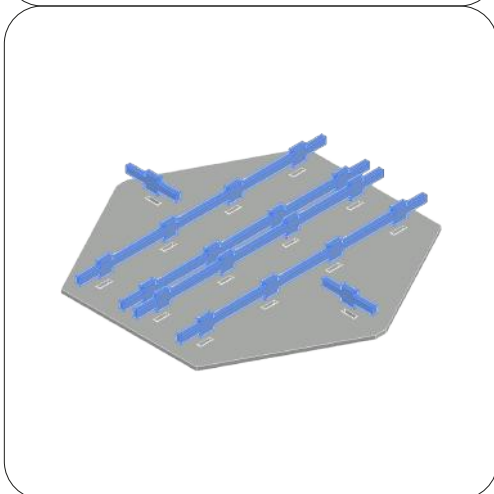
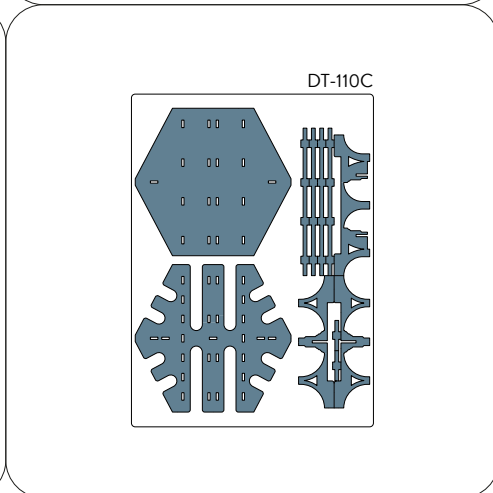
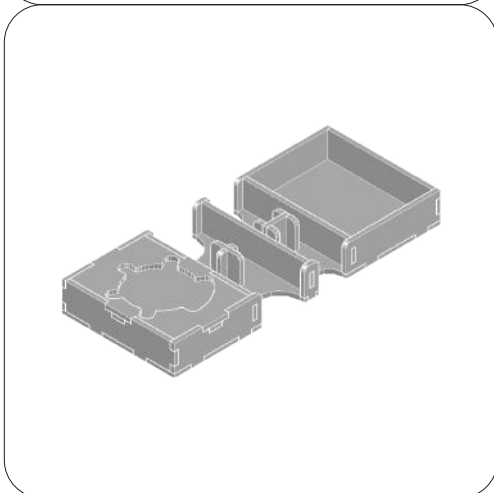
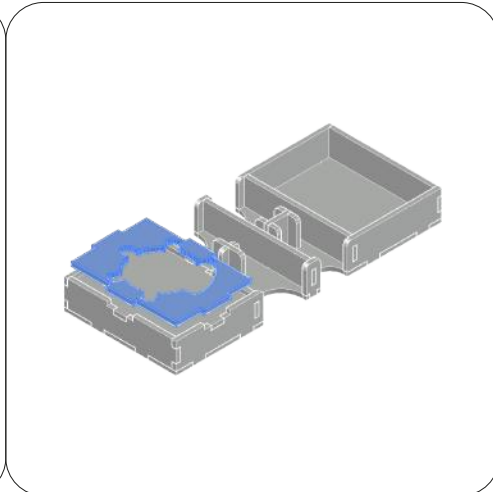
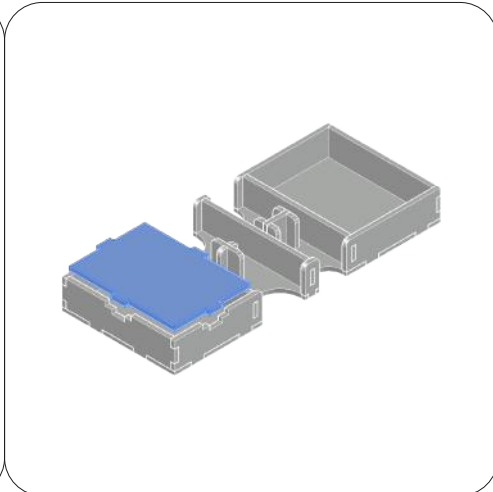
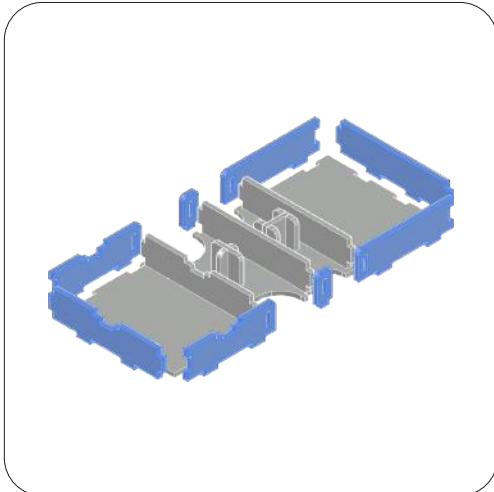

REBOXING SEQUENCE!



**VERTICAL
STORAGE
SAFETY**



Every piece will stay in its slot. Follow the reboxing sequence to properly store your organizer. We recommend using a h-band to avoid accidental box opening. Don't shake. Ogni componente rimarrà al suo posto. Segui la sequenza di reinserimento per riporre nella maniera corretta il tuo organizer. Consigliamo l'utilizzo di una h-band per evitare aperture accidentali. Non scuotere.



Non-recyclable waste.
Smaltire i materiali di
scarto nell'indifferenziata.

All trademarks and copyrights are the property of their respective owners.
This product is not a toy. Contains small parts that can be swallowed or inhaled. 14+