

# ORGANIZER - COMPATIBLE WITH SETI

SEARCH FOR EXTRATERRESTRIAL INTELLIGENCE

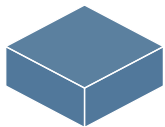

35.5 x 24.5 x 5.3 cm  
SIZE ONCE ASSEMBLED

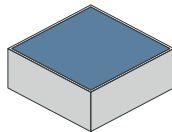

FITS INTO THE GAME BOX.  
FLUSH CLOSURE



FITS BOTH SLEEVED  
AND UNSLEEVED CARDS

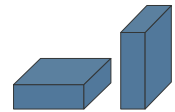

COMPATIBLE WITH  
BOTH HORIZONTAL OR  
VERTICAL STORAGE



Any doubt?  
Check out our FAQ page  
or download the digital  
version of the instructions  
on our website!

All trademarks and copyrights are the property of their respective owners.  
This product is not a toy. Contains small parts that can be swallowed or inhaled. 14+



## ORGANIZER - COMPATIBLE WITH SETI: SEARCH FOR EXTRATERRESTRIAL INTELLIGENCE



### TUTORIAL - THE DICETROYERS DICE!

Among the pieces to assemble, you'll find a dice. This is not part of the organizer, but it can be a good starting point to practice!

Tra i materiali da assemblare troverai un dado. Questo componente non fa parte dell'organizer, né del gioco, ma è un ottimo punto di partenza per fare un po' di pratica.

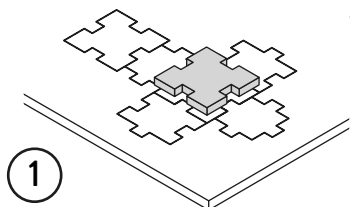

1

Gently take off  
all the pieces.  
Stacca delicatamente  
dal foglio tutti i pezzi.

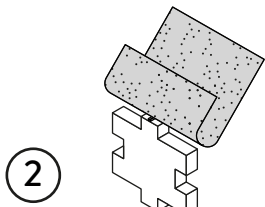

2

If necessary, use sand paper to  
smoothen the borders.  
Se necessario rifila con carta  
vetrata per legno eventuali  
imperfezioni dei pezzi.

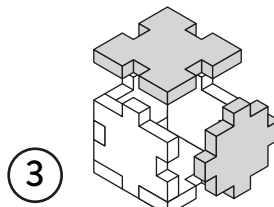

3

Get familiar with  
all the pieces  
and check the correct assembly  
sequence.  
Prendi familiarità con tutti  
i pezzi, per assicurarti  
che la sequenza di assemblaggio sia  
corretta.

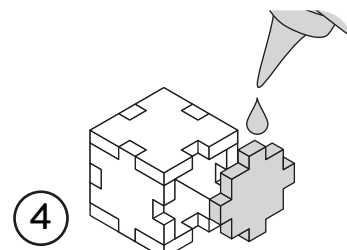

4

Once verified the correct assembly  
sequence, just add a small quantity  
of PVA glue on every joint.  
Dopo aver verificato  
la sequenza di assemblaggio  
aggiungi una piccola quantità di  
colla vinilica su tutti  
gli incastri per garantirne  
la durata nel tempo.

## INSTRUCTIONS

A



183A

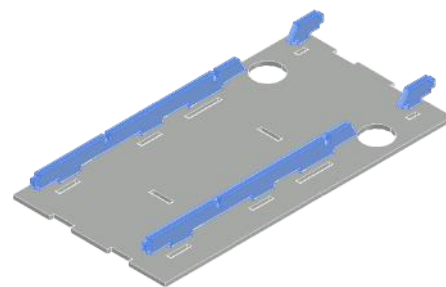
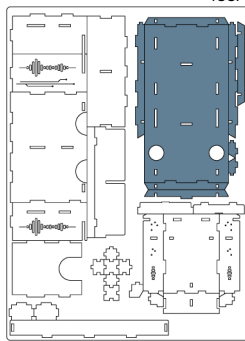

B

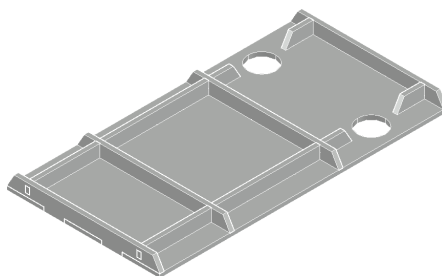
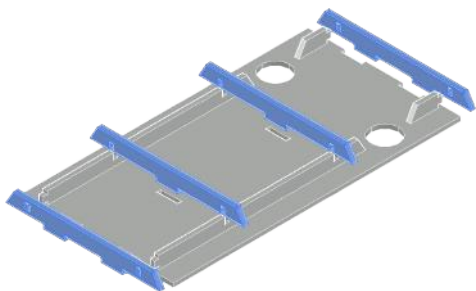

183A

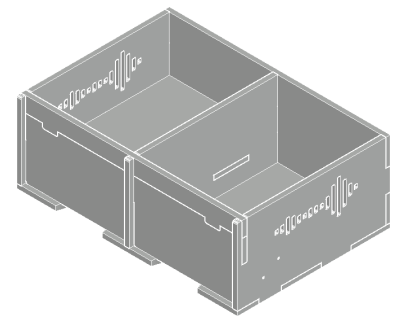
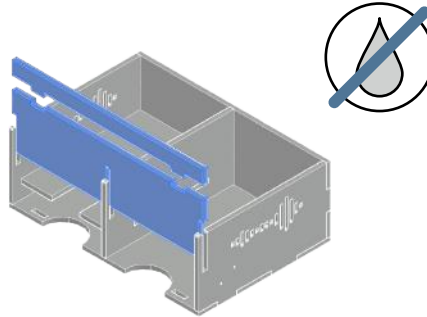
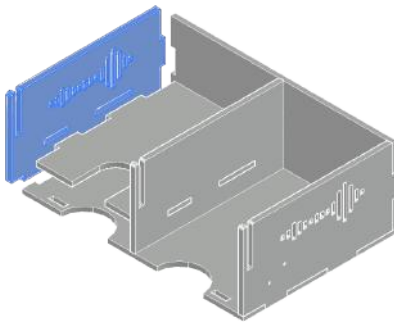
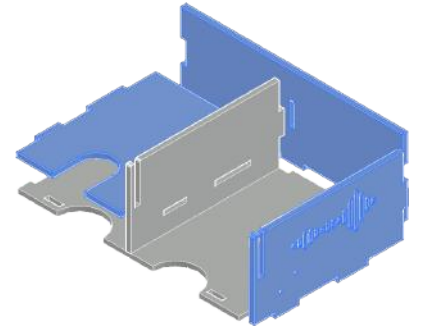
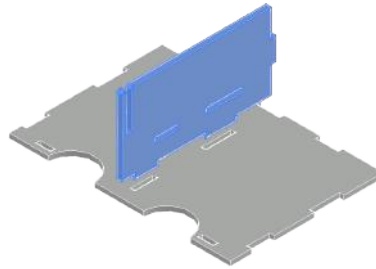
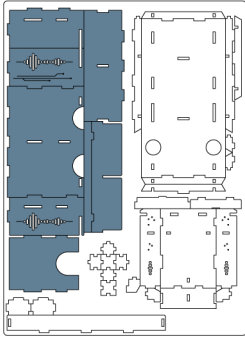

NOTE: Don't use glue on these joints; these pieces can be removed during the game. Non usare colla su questi incastri, pezzi rimovibili durante il gioco.

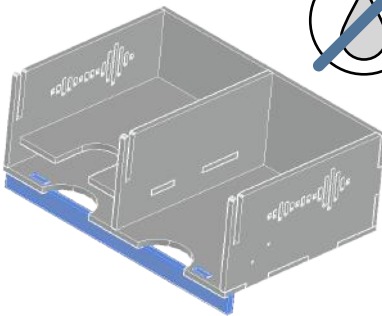

NOTE: The gate can be used to tilt the card holder. La saracinesca può essere utilizzata per inclinare il portacarte.

C



183A

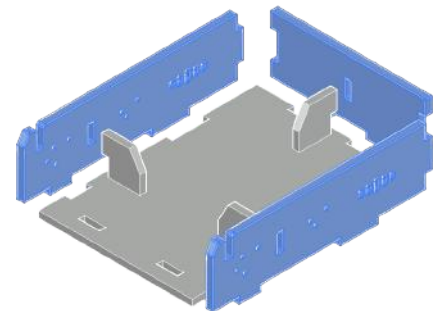
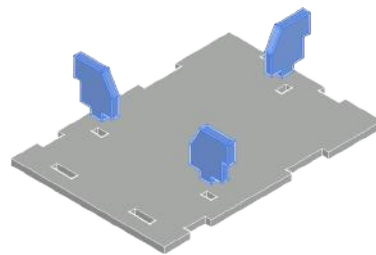
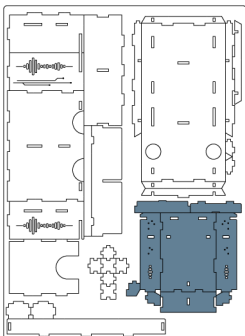

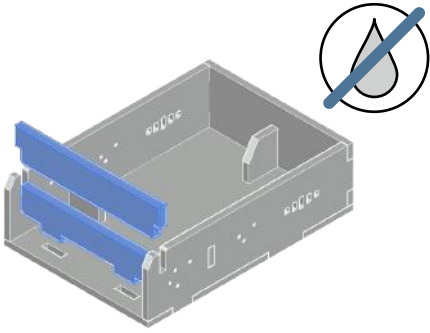

NOTE: Don't use glue on these joints; these pieces can be removed during the game. Non usare colla su questi incastri, pezzi rimovibili durante il gioco.

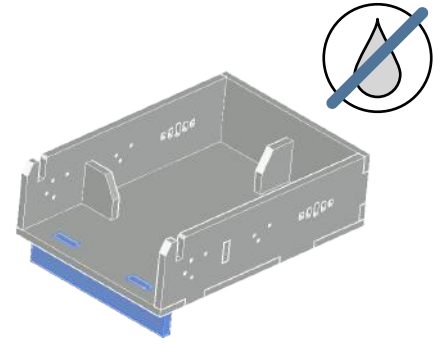
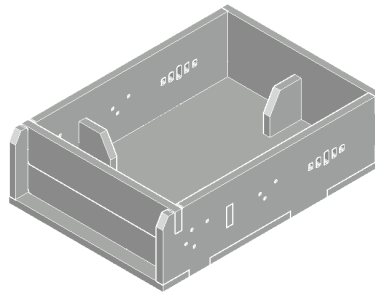

NOTE: The gate can be used to tilt the card holder. La saracinesca può essere utilizzata per inclinare il portacarte.

D

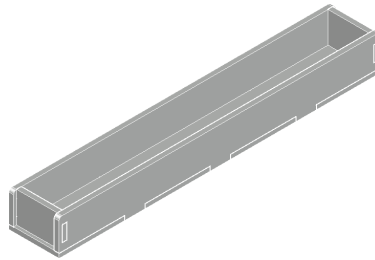
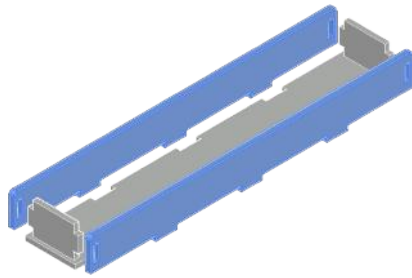
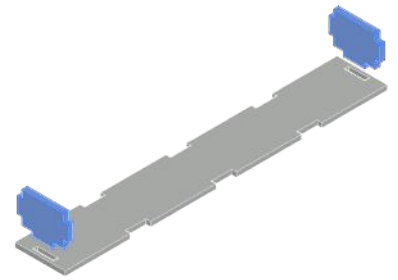
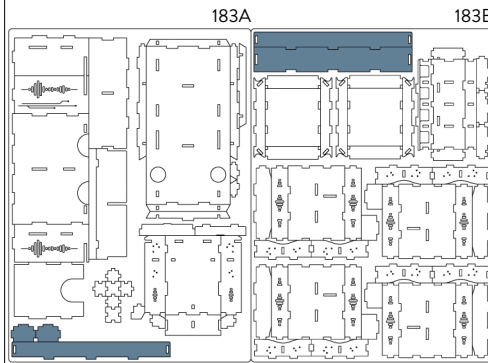

E

2x

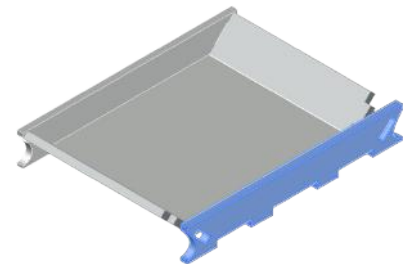
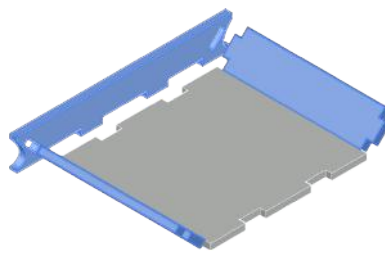
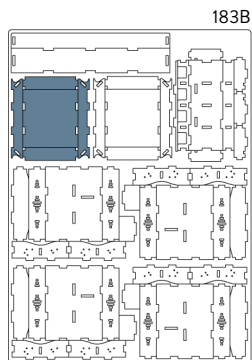

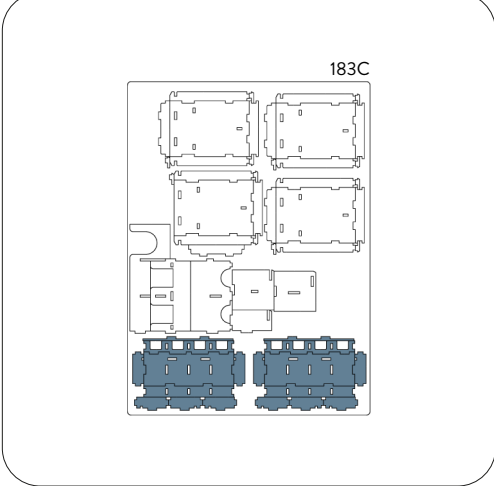
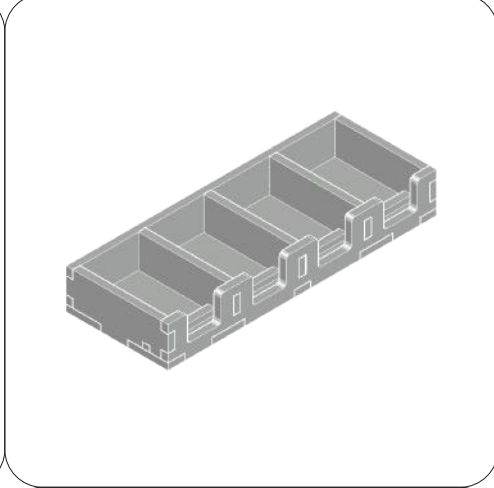
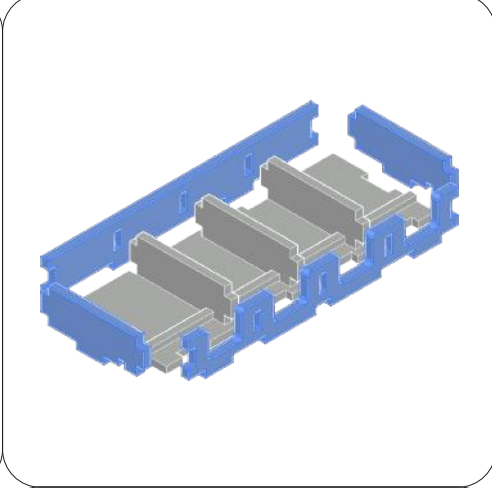
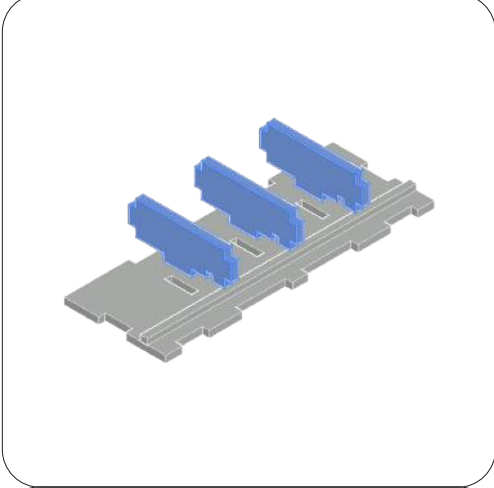
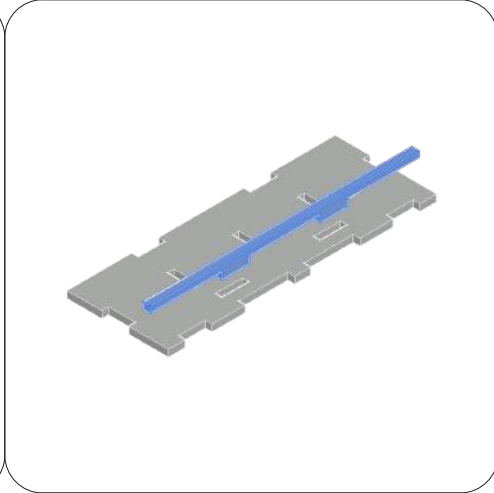
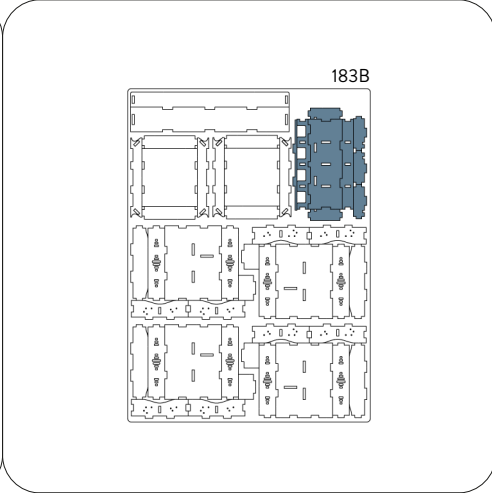
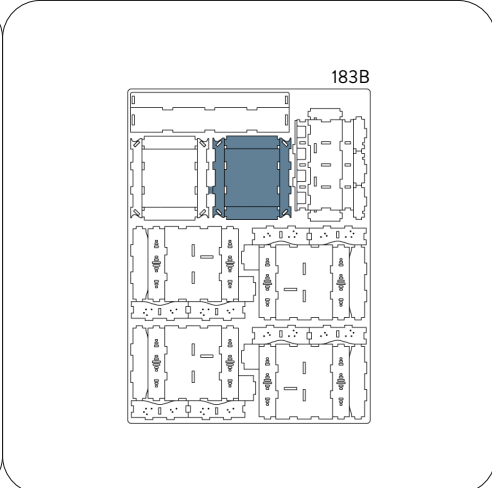
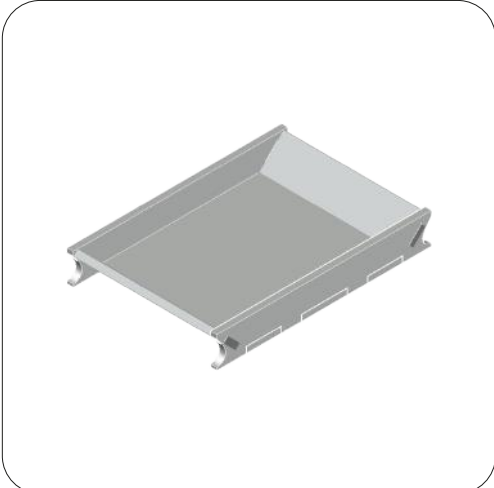

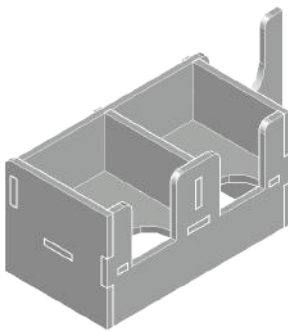
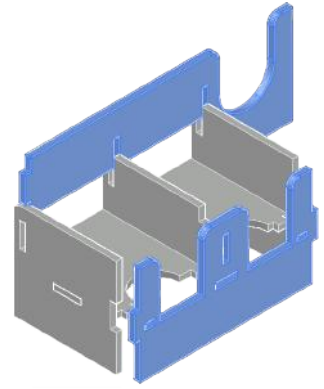
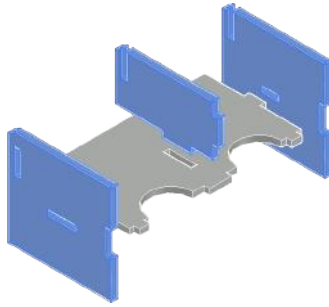
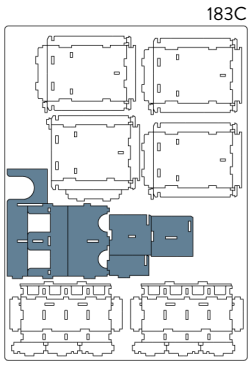

H



4x

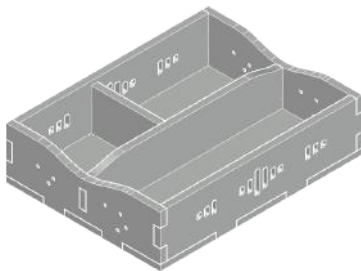
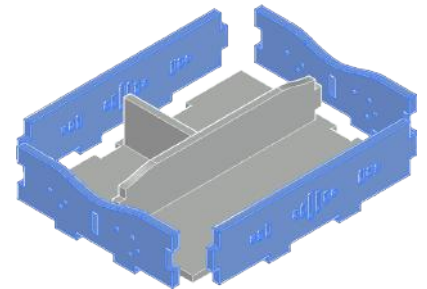
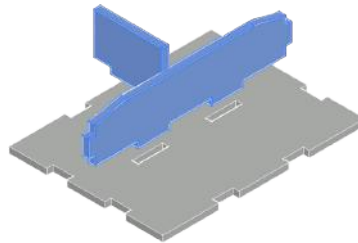
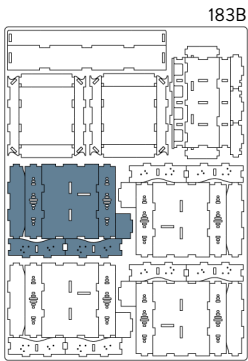

183B

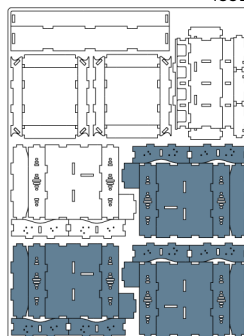

I



4x

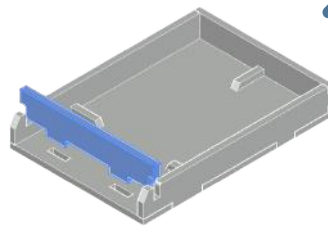
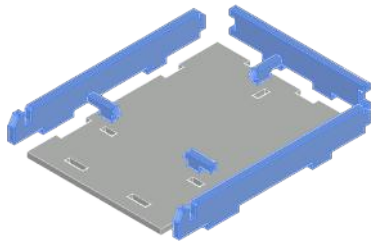
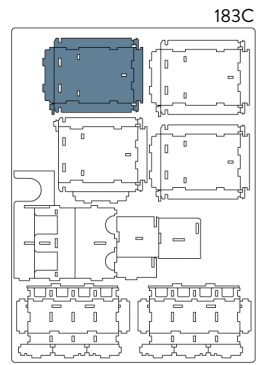

NOTE: Don't use glue on this joint; this piece can be removed during the game. Non usare colla su questo incastro, pezzo rimovibile durante il gioco.

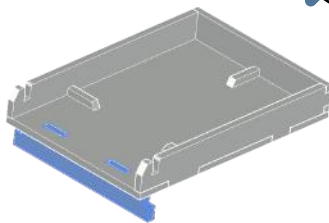
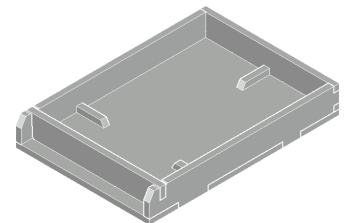

NOTE: The gate can be used to tilt the card holder. La saracinesca può essere utilizzata per inclinare il portacarte.

183C

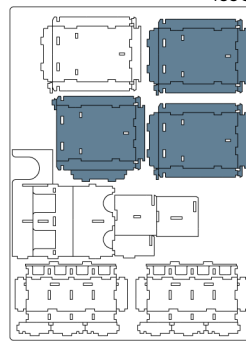

## REBOXING SEQUENCE!

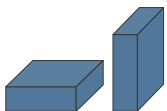

COMPATIBLE WITH BOTH HORIZONTAL OR VERTICAL STORAGE

Follow the reboxing sequence to properly store your organizer. We recommend using a h-band to avoid accidental box opening. Segui la sequenza di reinserimento per riporre nella maniera corretta il tuo organizer. Consigliamo l'utilizzo di una h-band per evitare aperture accidentali.



Non-recyclable waste.  
Smaltire i materiali di scarto nell'indifferenziata.

All trademarks and copyrights are the property of their respective owners.  
This product is not a toy. Contains small parts that can be swallowed or inhaled. 14+