

Assembly Instructions

The package contains 5 sheets: one double and three single sheets.

After assembly the trays are put in up to two layers in the original game box.

Ordinary PVA glue is required when assembling each tray.

Please make sure you **dry-assemble** each tray correctly before gluing it together.

Please check www.foldedspace.com for general assembly tips.

FS-TRANSG

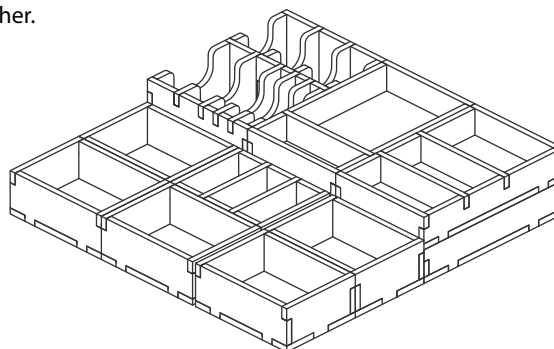

Sheet 1, 2 Sheet 3 Sheet 4 Sheet 5

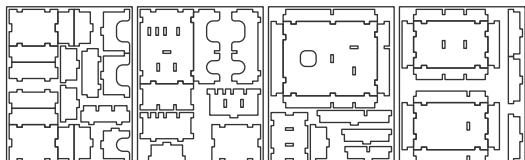

Tray 1a, b, c, d, e

(the trays are identical)

Sheet 1, 2, 3

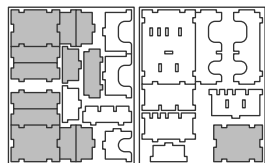

Step 1

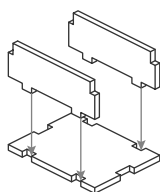

Step 2

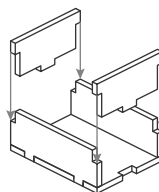

Finished tray

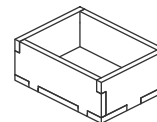

Tray 2

Sheet 1, 2, 3, 4

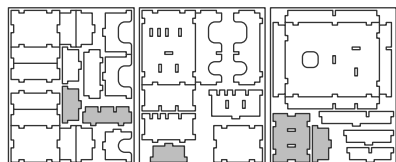

Step 1

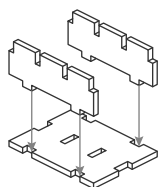

Step 2

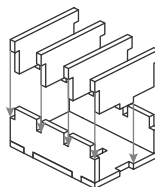

Finished tray

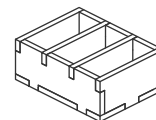

Tray 3

Sheet 5

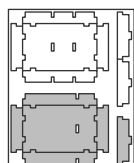

Step 1

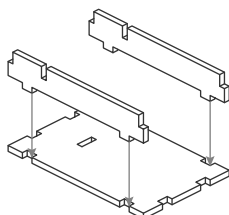

Step 2

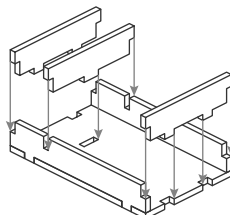

Finished tray

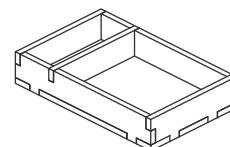

Tray 4

Sheet 5

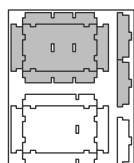

Step 1

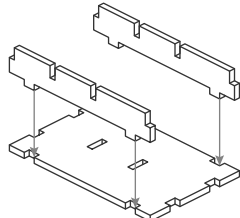

Step 2

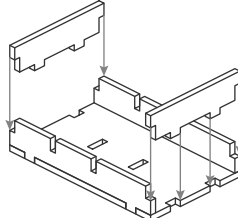

Step 3

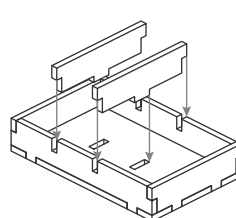

Finished tray

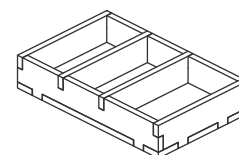

Tray 5
Sheet 4

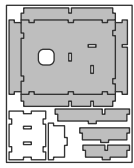

Step 1

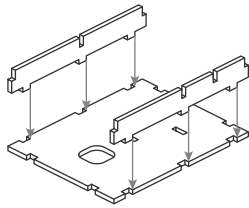

Step 2

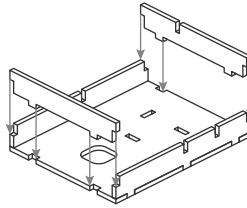

Step 3

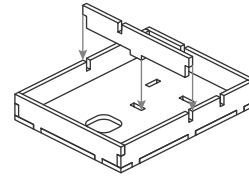

Step 4

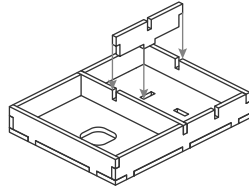

Step 5

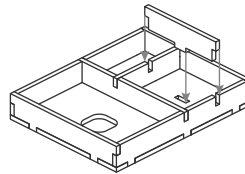

Finished tray

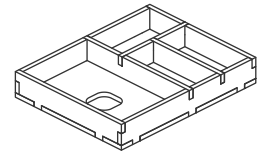

Tray 6

Sheet 1,2,3

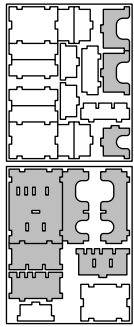

Step 1

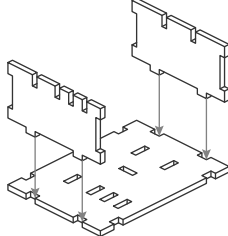

Step 2

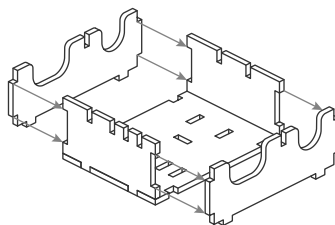

Step 3

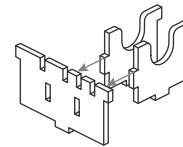

Step 4

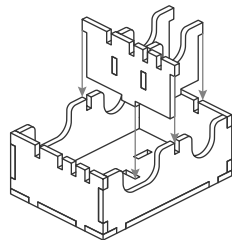

Step 5

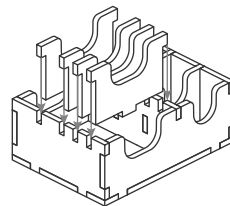

Finished tray

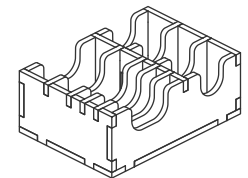

FS-TRANSG

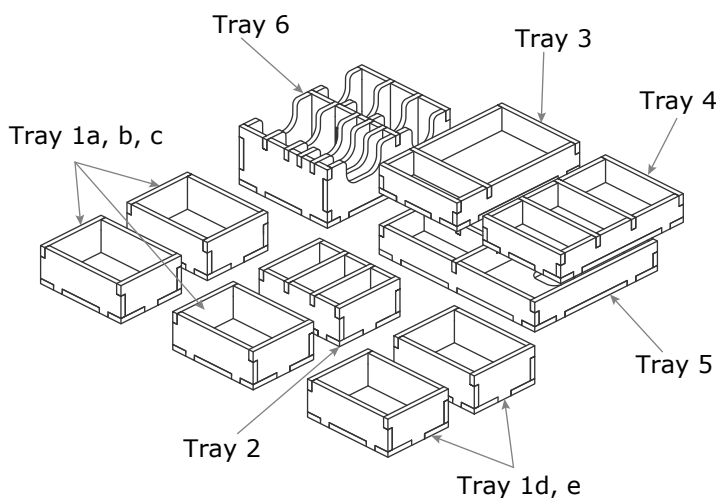

Please check www.foldedspace.com for photos of this insert in use.

Tray legend

- Tray 1a, b, c, d, e - player pieces (captains, crew workers, starships, tech, score, level, priority & politics level markers, outposts & fleet income tiles)
- Tray 2 - bonus tiles
- Tray 3 - credits
- Tray 4 - wooden resource pieces (energy, mineral, alien)
- Tray 5 - player aid cards, pirate tokens, skill tiles and round counter, lieutenant, second (white) starship, & 3rd captain tiles (for 2-player game)
- Tray 6 - objective, wealth, galactic decree, technology & mission cards, and planets (wilderness, mining, & action)

Note: there is room on top of the insert for only one rule book. To avoid lid lift please store additional language rule books elsewhere.