

FS-CLKCATA Insert compatible with Clank! Catacombs®

Includes space for Adventuring Party® and Lairs and Lost Chambers® expansions.

Assembly Instructions

The package contains 6 sheets: two double and two single sheets.

After assembly the trays are put in up to three layers in the original game box.

Ordinary PVA glue is required when assembling each tray.

Please make sure you **dry-assemble** each tray correctly before gluing it together.

Please check www.foldedspace.com for general assembly tips.



FS-CLKCATA

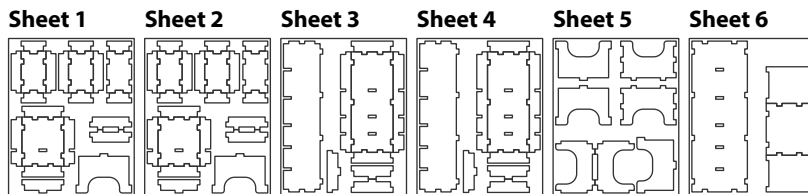
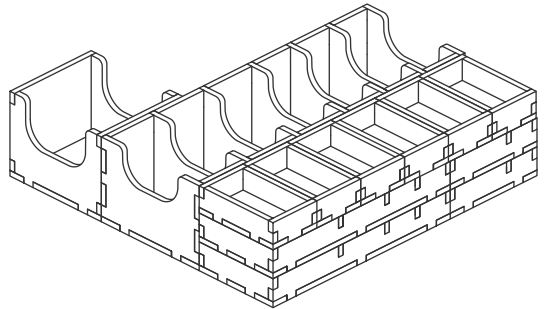

Tray 1a, b, c, d, e, f (the trays are identical)

Sheet 1, 2

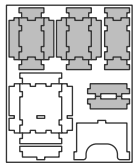

Step 1

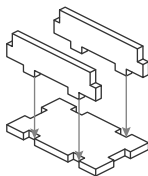

Step 2

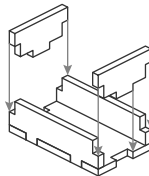

Finished tray

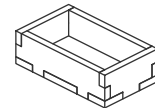

Tray 2

Sheet 5, 6

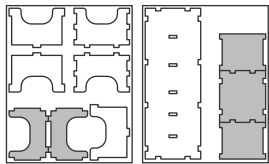

Step 1

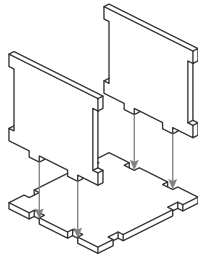

Step 2

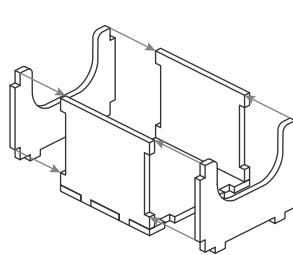

Finished tray

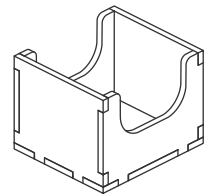

Tray 3a, b

(the trays are identical)

Sheet 1, 2

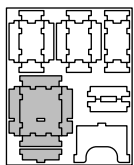

Step 1

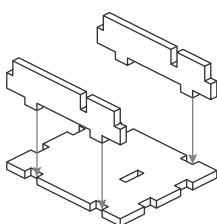

Step 2

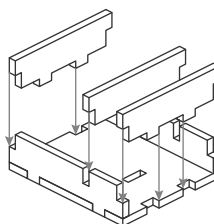

Finished tray

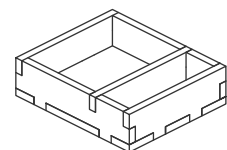

FS-CLKCATA Insert compatible with Clank! Catacombs®

Includes space for Adventuring Party® and Lairs and Lost Chambers® expansions.



Tray 4a, b

Sheet 3, 4

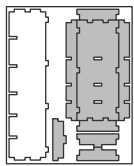

(the trays are identical)

Step 1

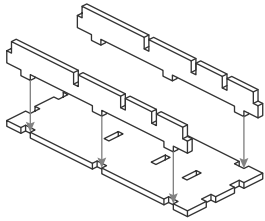

Step 2

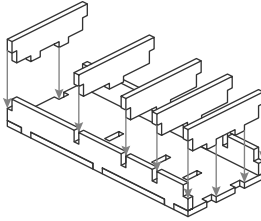

Finished tray

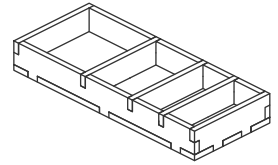

Tray 5

Sheet 1, 2, 3, 4, 5, 6

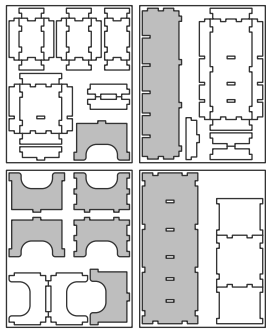

Step 1

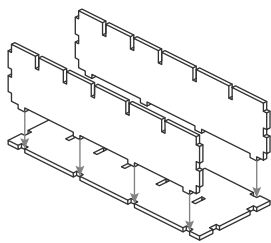

Step 2

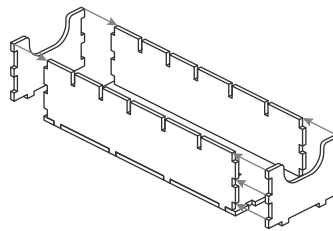

Step 3

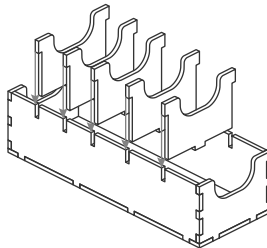

Finished tray

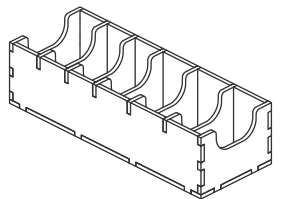

FS-CLKCATA

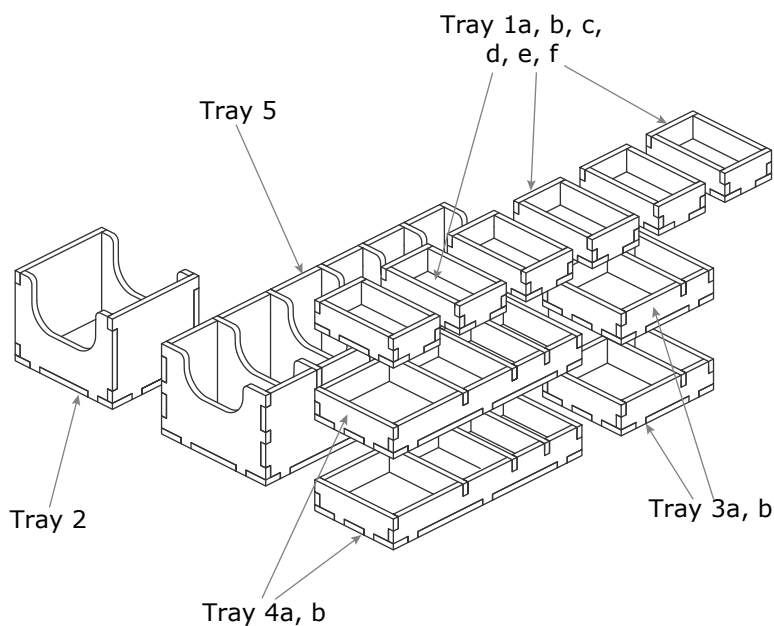

Please check www.foldedspace.com for photos of this insert in use.

Tray legend

- Tray 1a, b, c, d, e, f - player components (Clank! cubes, player pawns, mastery tokens)
- Tray 2 - dragon bag (filler tray)
- Tray 3a - monkey idols & market tokens (backpacks, blood amulets, burglar's kits, crowns & invisibility cloaks) and dragon, boss & monster markers
- Tray 3b - dragon & ghost cubes and character tokens
- Tray 4a, b - gold and artifacts
- Tray 4b - major secrets, minor secrets, prisoner tokens and lockpick tokens
- Tray 5 - cards (starting decks, reserve cards, dungeon deck cards, character starting decks)

Note: the double-sided starting tile, along with the square dungeon tiles, character boards, market boards & the side board fit into the empty space next to trays 2 and 5. The Clank! board and rule books go on top of the insert.