

FS-ORLOJ Insert compatible with Orloj: The Prague Astronomical Clock®



Assembly Instructions

The package contains 4 single sheets.

After assembly the trays are put in up to two layers in the original game box.

Ordinary PVA glue is required when assembling each tray.

Please make sure you **dry-assemble** each tray correctly before gluing it together.

Please check www.foldedspace.com for general assembly tips.

FS-ORLOJ

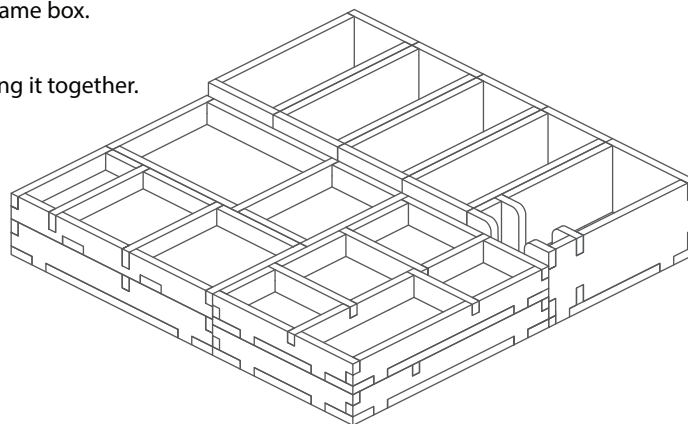
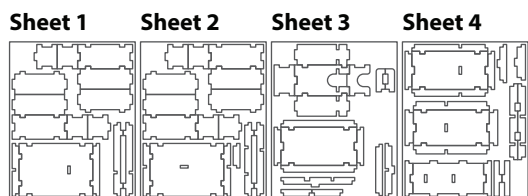

Tray 1a, b, c, d (the trays are identical)

Sheet 1, 2

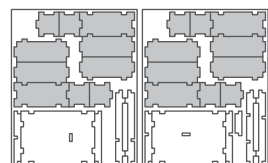

Step 1

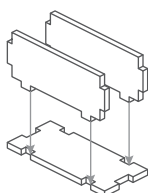

Step 2

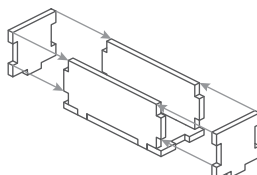

Finished tray

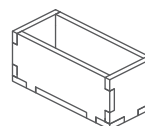

Tray 2

Sheet 3

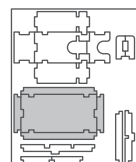

Step 1

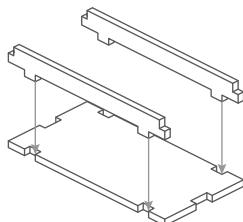

Step 2

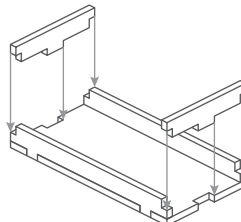

Finished tray

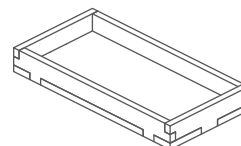

Tray 3

Sheet 4

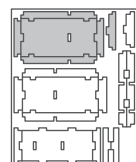

Step 1

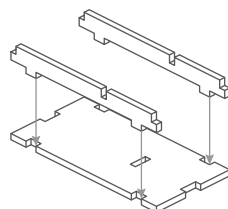

Step 2

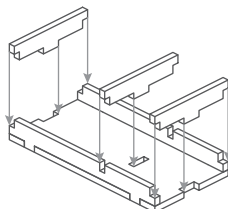

Finished tray

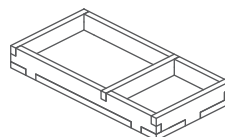

Tray 4

Sheet 4

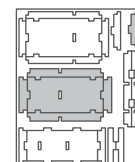

Finished tray

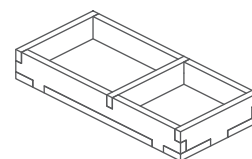

To assemble, follow the steps for Tray 3.

Tray 5

Sheet 4

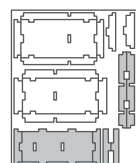

Step 1

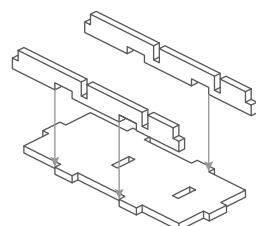

Step 2

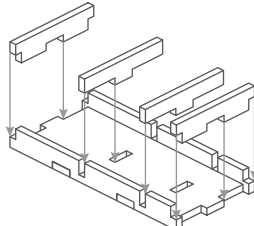

Finished tray

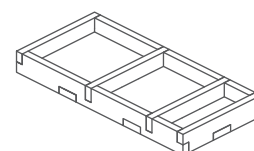

FS-ORLOJ Insert compatible with Orloj: The Prague Astronomical Clock®



Tray 6 Sheet 3

Step 1

Step 2

Step 3

Finished tray

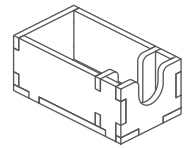
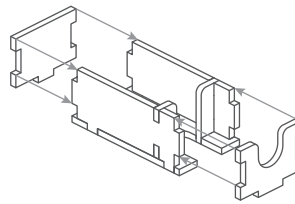
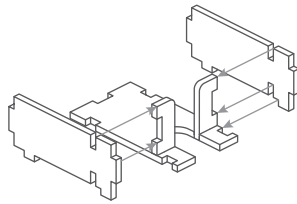
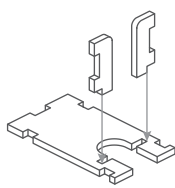
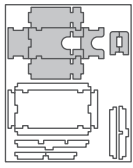

Tray 7 Sheet 1, 3

Step 1

Step 2

Step 3

Finished tray

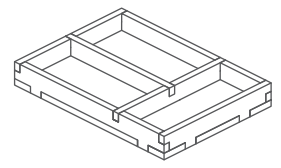
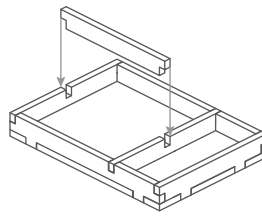
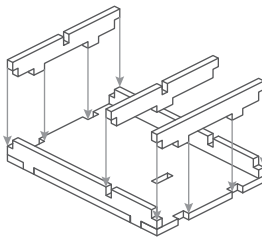
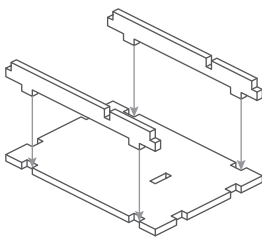
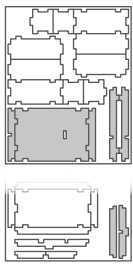

Tray 8 Sheet 2, 3

Step 1

Step 2

Step 3

Step 4

Finished tray

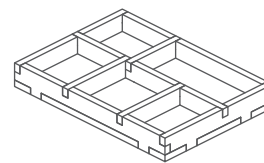
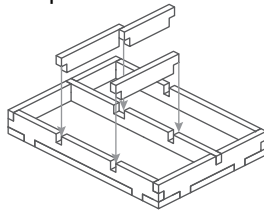
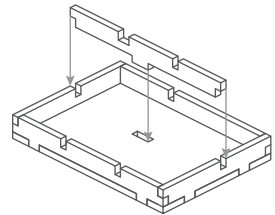
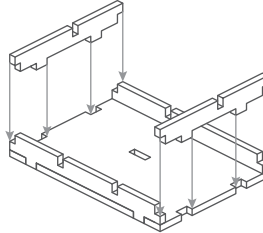
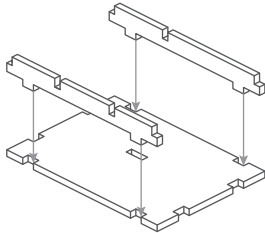
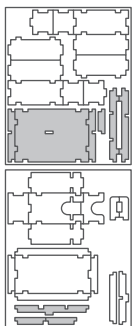

FS-ORLOJ

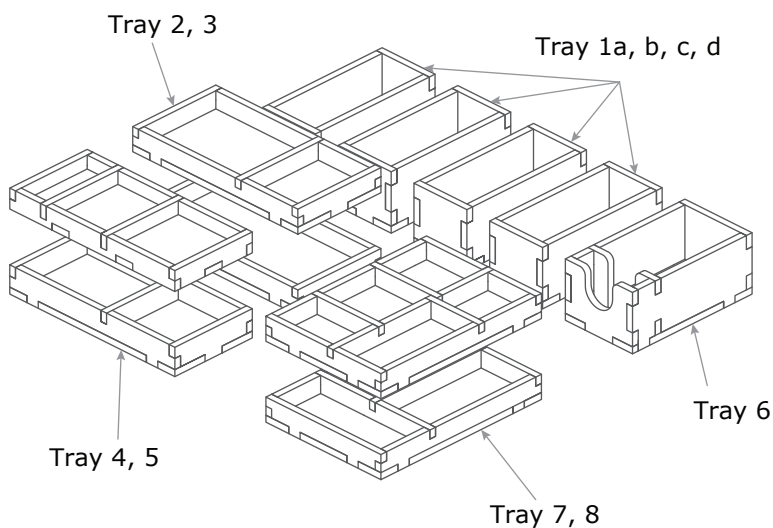

Please check www.foldedspace.com for photos of this insert in use.

Tray legend

Tray 1a, b, c, d - player components (forge, warehouse, production/hammer cubes, rooster/mastery discs, workers, sculptor, apostle tiles, scoring marker & 5 deviation tokens)

Tray 2 - solo mode tiles (scoring, mastery, mastery track & mastery track objective, end-of-round action, conditions met tiles)

Tray 3 - calendar sections, scrolls

Tray 4 - assistants, and royal scrolls, rotation axis, moon & hammer discs, round marker, painter, & golden rooster

Tray 5 - blocked zodiac dials, gold pieces, and coins

Tray 6 - cards, and mastery stained-glass windows

Tray 7 - paint, wood and iron pieces

Tray 8 - month, blocked month & zodiac dials, common stained-glass window objectives, and common objective bonuses

Note: there is room for only one language rulebook without lid lift.